

# SHINDENGEN

## Super Fast Recovery Rectifiers

Dual

# SF10LC40

## 400V 10A

### FEATURES

- Low noise
- trr50ns
- Fully Isolated Molding
- Dielectric strength 2kV guaranteed

### APPLICATION

- Switching power supply
- Free Wheel
- Home Appliances, Office Equipment
- Telecommunication, Factory Automation

### OUTLINE DIMENSIONS

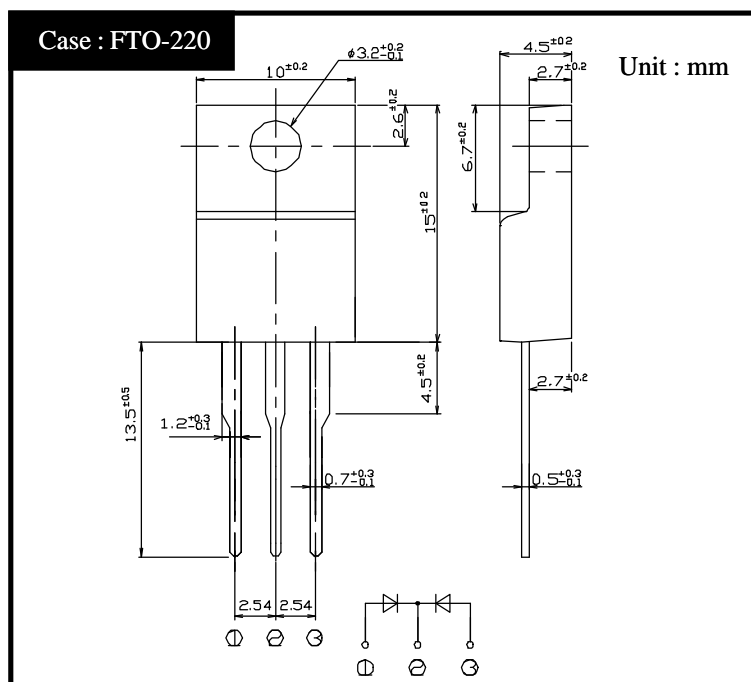

### RATINGS

Absolute Maximum Ratings (If not specified Tc=25 )

Item	Symbol	Conditions	Ratings	Unit
Storage Temperature	T <sub>stg</sub>		-40 ~ 150	
Operating Junction Temperature	T <sub>j</sub>		150	
Maximum Reverse Voltage	V <sub>RM</sub>		400	V
Average Rectified Forward Current	I <sub>O</sub>	50Hz sine wave, R-load, Rating for each diode I <sub>O</sub> /2, Tc=115	10	A
Peak Surge Forward Current	I <sub>FSM</sub>	50Hz sine wave, Non-repetitive 1 cycle peak value, T <sub>i</sub> =25	80	A
Dielectric Strength	V <sub>dis</sub>	Terminals to case, AC 1 minute	2	kV
Mounting Torque	TOR	(Recommended torque 0.3N·m)	0.5	N·m

Electrical Characteristics (If not specified Tc=25 )

Item	Symbol	Conditions	Ratings	Unit
Forward Voltage	V <sub>F</sub>	I <sub>F</sub> =5A, Pulse measurement, Rating of per diode	Max.1.3	V
Reverse Current	I <sub>R</sub>	V <sub>R</sub> =V <sub>RM</sub> , Pulse measurement, Rating of per diode	Max.10	μA
Reverse Recovery Time	trr	I <sub>F</sub> =0.5A, I <sub>R</sub> =1A, Rating of per diode	Max.50	ns
Thermal Resistance	jc	junction to case	Max.2.3	/W

# SF10LC40 Forward Voltage

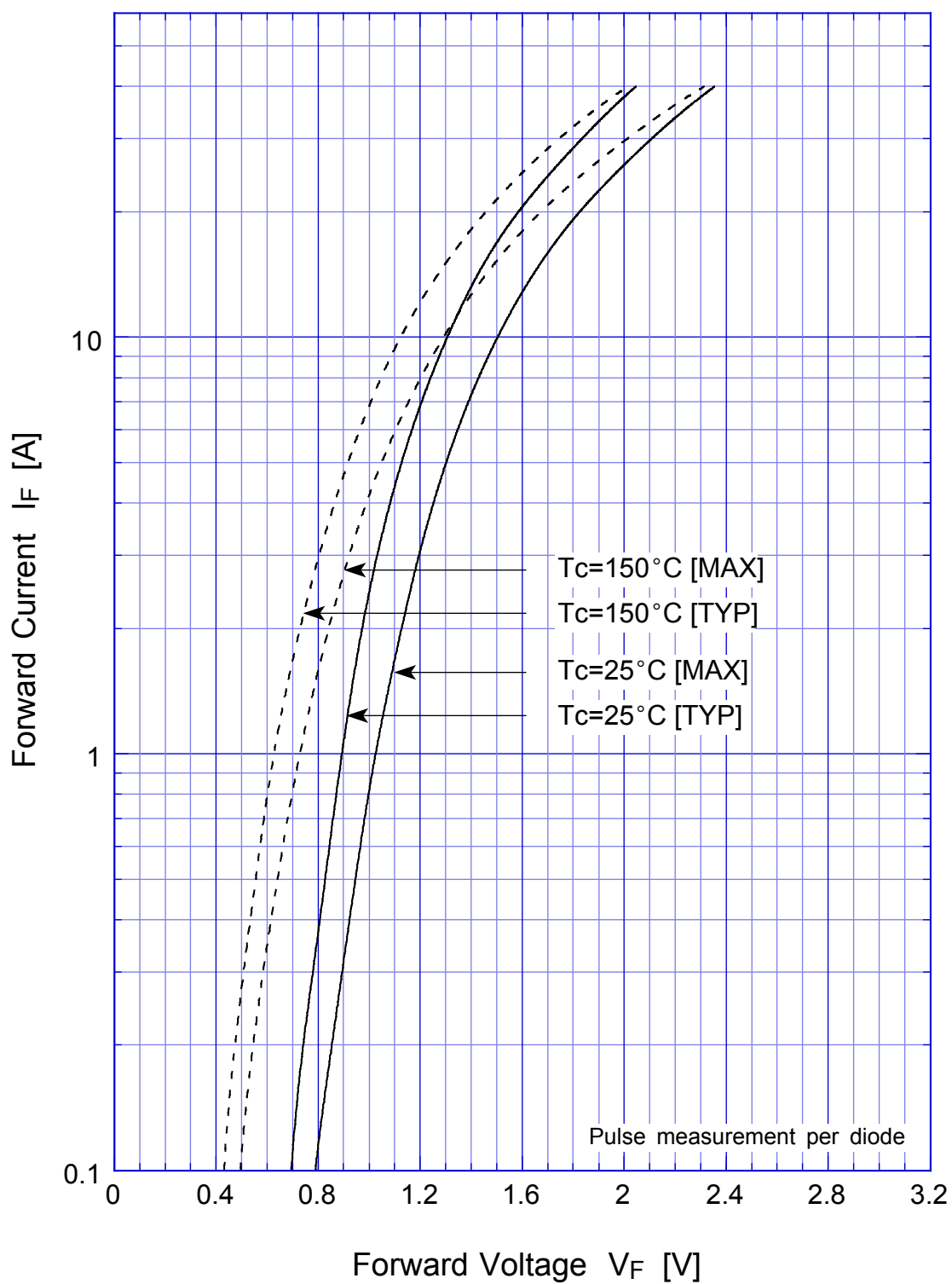

## SF10LC40 Forward Power Dissipation

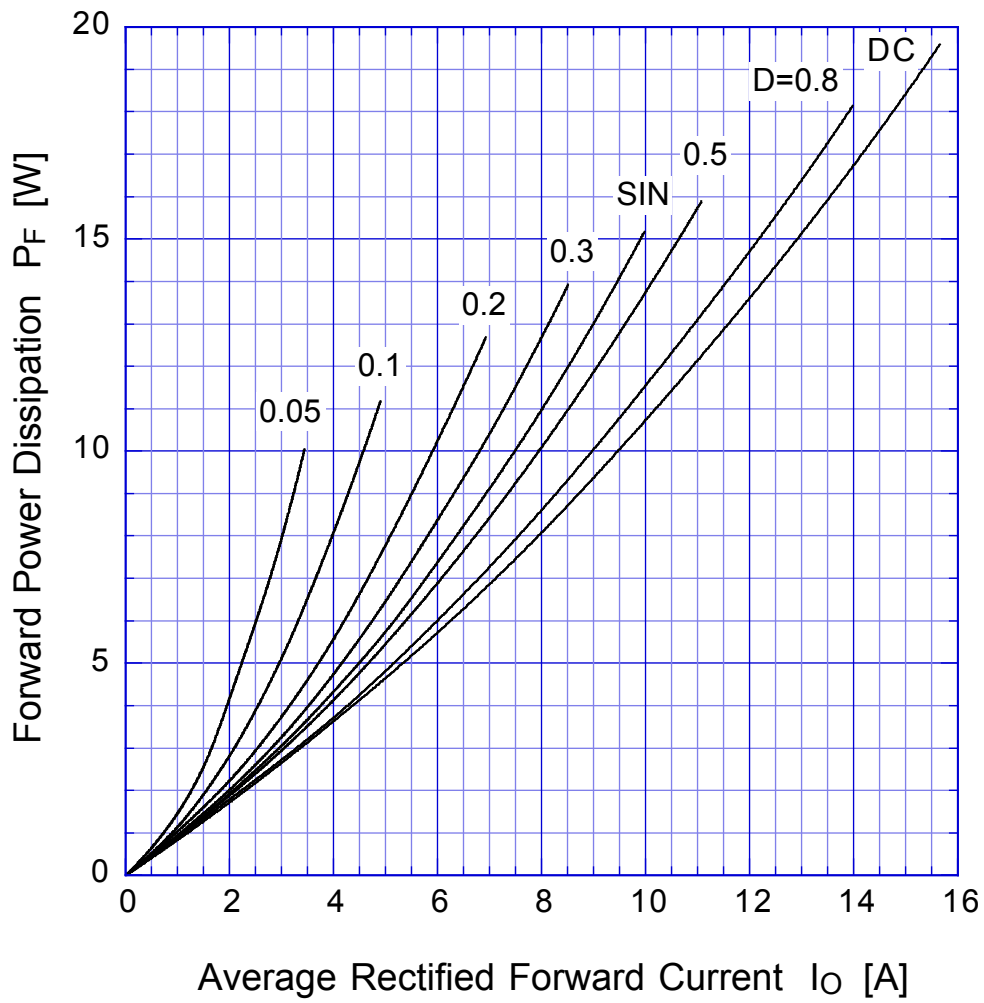

$T_j = T_{jmax}$

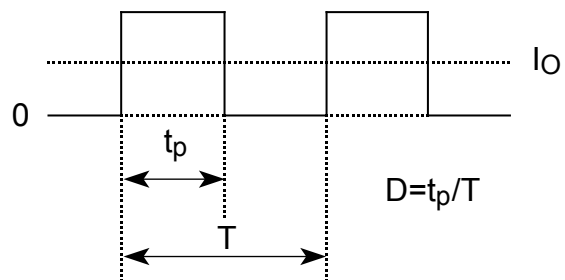

# SF10LC40

## Derating Curve

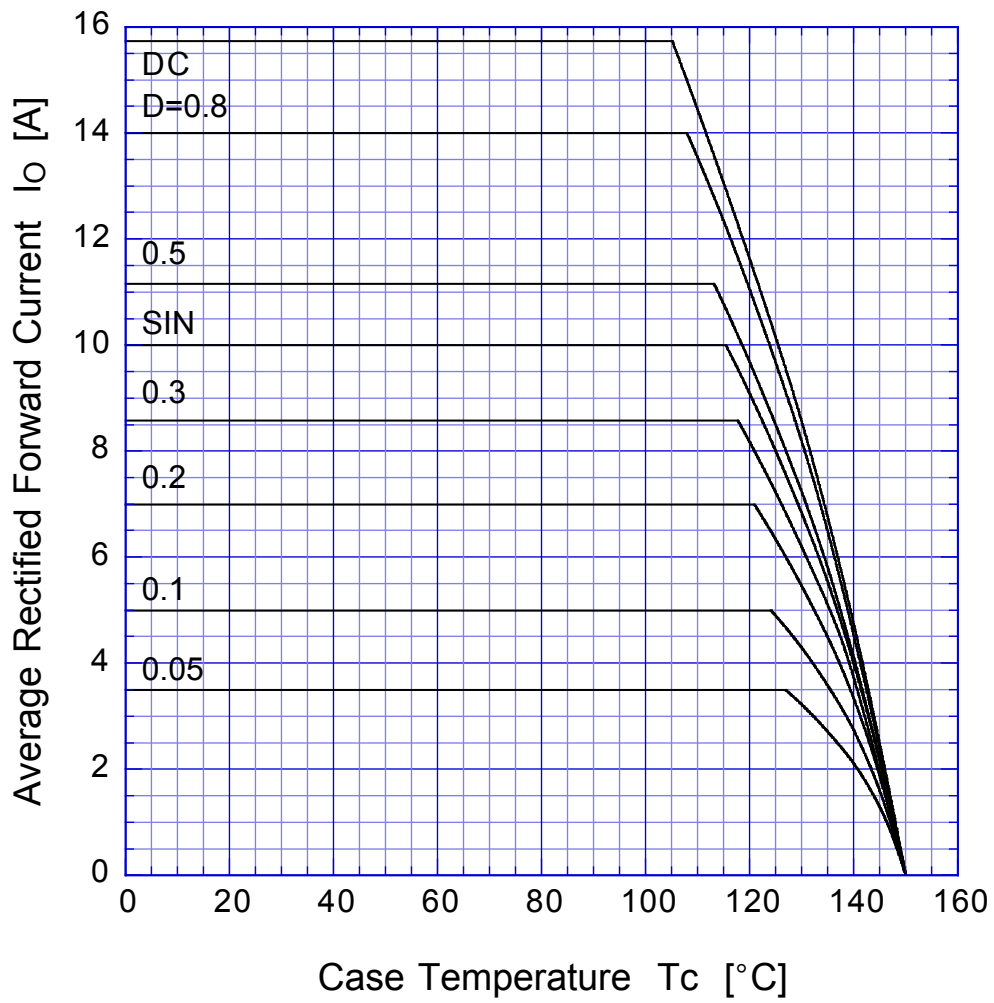

$$V_R = V_{RM}$$

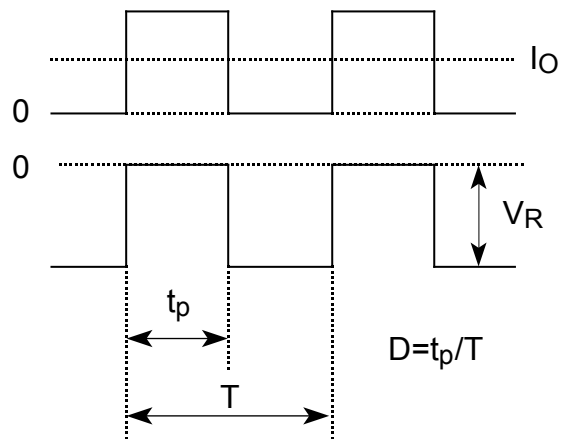

# SF10LC40 Peak Surge Forward Capability

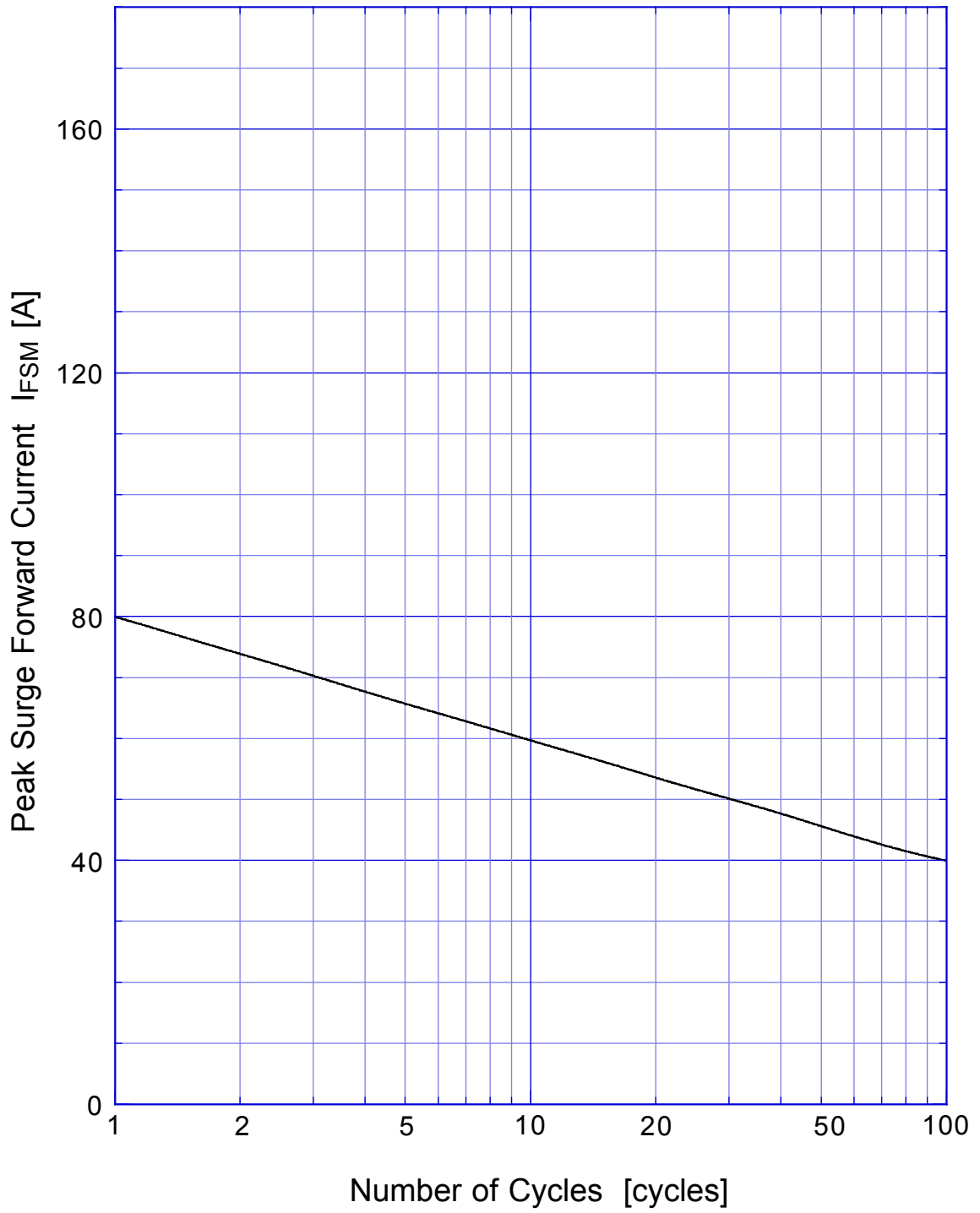

# SF10LC40 Junction Capacitance

